

# 产品数据表

## HH-504-7-xx-PH3030

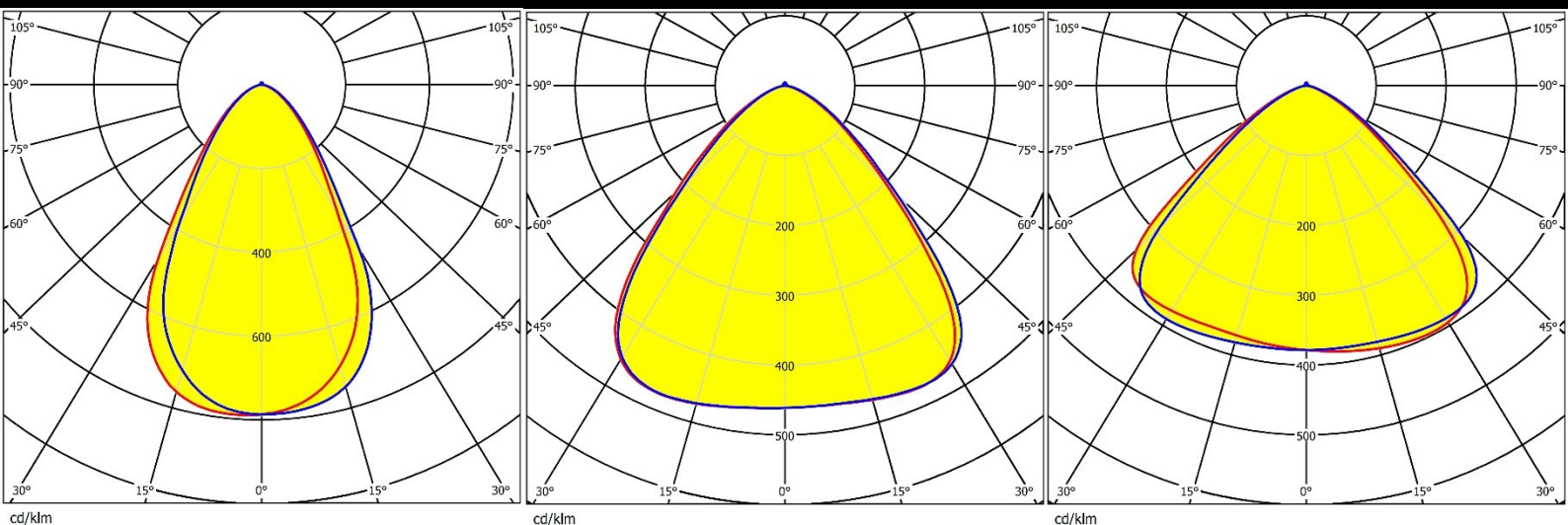
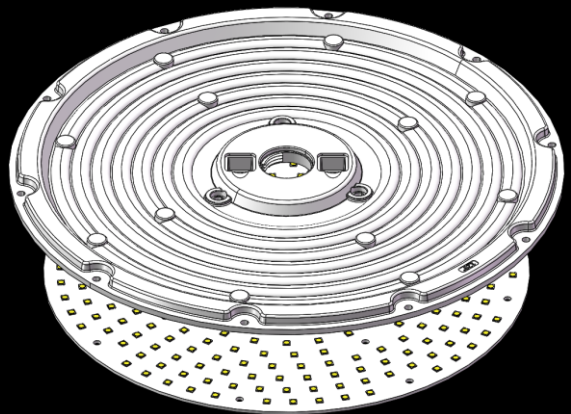
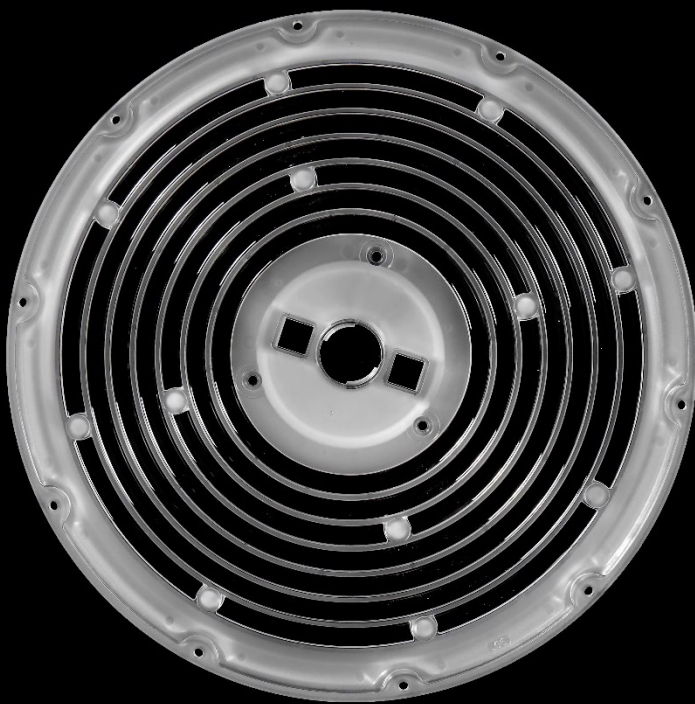

深圳市汉辉光电有限公司

Shenzhen Hanhui Photoelectricity Co.,Ltd

地址：深圳市宝安区石岩街道水田社区石龙仔路71号1栋  
ADD：Building 1, No. 71, Shilongzai Road, Shuitian Community,  
Shiyan Street, Bao'an District, Shenzhen, China

TEL:86-755-29232420 FAX:86-755-83723765

http://www.szhanhui.com http://linsen4880.1688.com



基本信息	.....	P.1
光学参数	.....	P.2-4
结构参数	.....	P.5
包装规格	.....	P.6

### \*产品编号说明

**HH-504-7-xx-PH3030**

H1

H2

H3

H4

H5

H6

**H1:** 公司拼音首字母 (Han Hui)

**H2:** 所属模具模号

**H3:** 光学面数量

**H4:** 透镜角度/类型 (如: 60、90、T2M、T3M)

**H5:** 光源厂家 (如: 科锐 CR、三星 SS、飞利浦 PH.....)

**H6:** 光源尺寸 (如:2835、3030、3535、.....)



## HH-504-7-xx-PH3030

## 基本信息

v1.0\_20230223

## ◆ 特征&amp;典型应用

- 3 种不同配光角度
- 效率高
- 均匀度优良
- 透镜无支架
- 工矿灯

## ◆ 材质信息

透镜材料：PC 1225Z

工作温度范围：-40℃~+110℃（上限值+120℃）

存储温度范围：-40℃~+110℃（上限值+120℃）

\*400nm~700nm 可见光平均透过率>90%

## ◆ 使用注意事项

1. 如有必要，用软性肥皂、水和软布清洗透镜。
2. 禁止用工业溶剂清洗透镜，例如酒精。
3. 拿透镜时请带手套，因为皮肤油会影响透镜光学特性。



# HH-504-7-xx-PH3030

## 光学参数

v1.0\_20230223

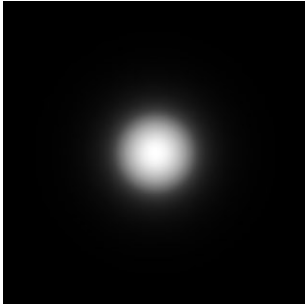
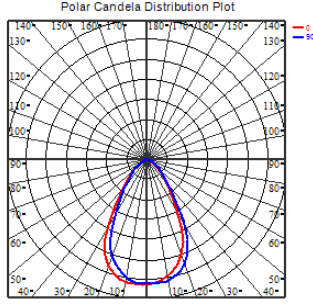
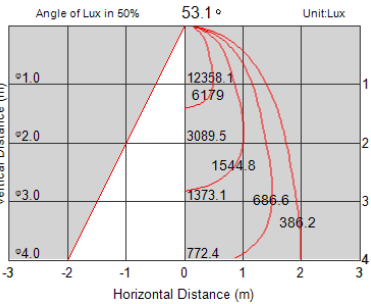
产品型号	半光强角	视场角*	cd/lm	IES 文件							
HH-504-7-60-PH3030	63°	110°	0.8	<a href="#">下载</a>							
											
光斑图	配光曲线	照度分布									
UGR 数据											
<u>UGR Table - Corrected</u>											
Reflectances											
Ceiling Cavity	70	70	50	50	30	70	70	50	50	30	
Walls	50	30	50	30	30	50	30	50	30	30	
Floor Cavity	20	20	20	20	20	20	20	20	20	20	
Room Size											
X=2H Y=2H	UGR Viewed Crosswise				UGR Viewed Endwise						
3H	21.1	22.3	21.5	22.6	23.0	21.6	22.8	22.0	23.1	23.5	
4H	21.9	23.0	22.3	23.3	23.7	22.6	23.7	23.0	24.0	24.4	
6H	22.0	23.0	22.5	23.4	23.8	22.9	23.9	23.3	24.3	24.7	
8H	22.0	22.9	22.4	23.3	23.7	23.0	24.0	23.5	24.3	24.8	
12H	22.0	22.8	22.4	23.2	23.7	23.0	23.9	23.5	24.3	24.8	
21.9	22.7	22.4	23.2	23.6	23.0	23.9	23.5	24.3	24.7		
4H	2H	21.4	22.4	21.8	22.8	23.2	21.9	22.9	22.3	23.3	23.7
3H	22.3	23.2	22.8	23.6	24.0	23.0	23.8	23.4	24.3	24.7	
4H	22.5	23.3	23.0	23.7	24.2	23.4	24.1	23.8	24.6	25.0	
6H	22.5	23.2	23.0	23.6	24.1	23.6	24.2	24.1	24.7	25.2	
8H	22.5	23.1	23.0	23.5	24.0	23.6	24.2	24.1	24.7	25.2	
12H	22.4	23.0	22.9	23.5	24.0	23.6	24.1	24.1	24.6	25.1	
8H	4H	22.6	23.2	23.1	23.6	24.1	23.4	24.0	23.9	24.5	25.0
6H	22.6	23.1	23.1	23.6	24.1	23.6	24.1	24.1	24.6	25.1	
8H	22.5	23.0	23.1	23.5	24.0	23.7	24.1	24.2	24.6	25.2	
12H	22.5	22.9	23.0	23.4	24.0	23.7	24.1	24.2	24.6	25.2	
12H	4H	22.5	23.1	23.0	23.6	24.1	23.4	23.9	23.9	24.4	24.9
6H	22.5	23.0	23.1	23.5	24.0	23.6	24.0	24.1	24.5	25.1	
8H	22.5	22.9	23.0	23.4	24.0	23.7	24.0	24.2	24.5	25.1	
Maximum UGR = 25.2											



# HH-504-7-xx-PH3030

## 光学参数

v1.0\_20230223

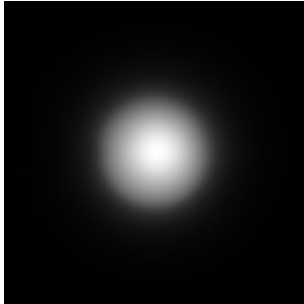
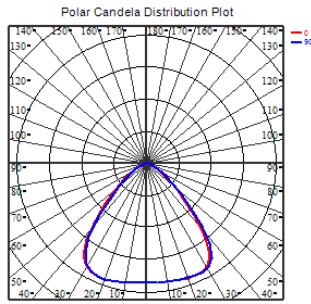
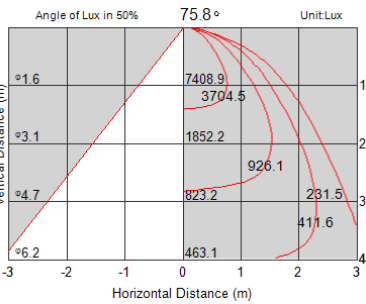
产品型号	半光强角	视场角*	cd/lm	IES 文件
HH-504-7-90-PH3030	87°	127°	0.48	<a href="#">下载</a>
				
光斑图	配光曲线	照度分布		
UGR 数据				
<b>UGR Table - Corrected</b>				
Reflectances				
Ceiling Cavity	70	70	50	50
Walls	50	30	50	30
Floor Cavity	20	20	20	20
Room Size	UGR Viewed Crosswise			
X=2H Y=2H	22.8	24.1	23.2	24.5
3H	23.4	24.6	23.8	24.9
4H	23.5	24.6	23.9	25.0
6H	23.5	24.5	23.9	24.9
8H	23.4	24.4	23.9	24.8
12H	23.4	24.3	23.8	24.7
4H	UGR Viewed Endwise			
2H	23.0	24.1	23.4	24.5
3H	23.7	24.6	24.1	25.0
4H	23.8	24.6	24.3	25.1
6H	23.8	24.5	24.3	25.0
8H	23.8	24.4	24.3	24.9
12H	23.7	24.3	24.2	24.8
8H	UGR Viewed Endwise			
4H	23.8	24.5	24.3	24.9
6H	23.8	24.3	24.3	24.8
8H	23.7	24.2	24.3	24.7
12H	23.7	24.1	24.2	24.6
12H	UGR Viewed Endwise			
4H	23.8	24.4	24.3	24.9
6H	23.7	24.2	24.3	24.7
8H	23.7	24.1	24.2	24.6
Maximum UGR = 26.2				



# HH-504-7-xx-PH3030

## 光学参数

v1.0\_20230223

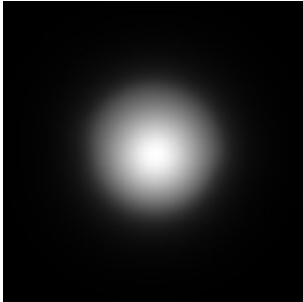
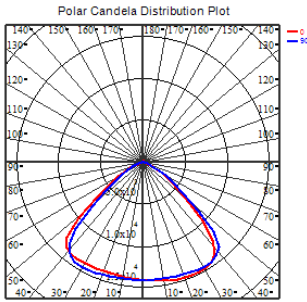
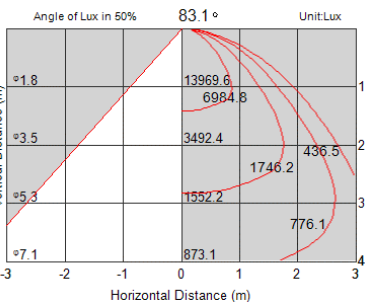
产品型号	半光强角	视场角*	cd/lm	IES 文件
HH-504-7-120-PH3030	101°	134°	0.4	<a href="#">下载</a>
				
光斑图	配光曲线	照度分布		
UGR 数据				
<b>UGR Table - Corrected</b>				
Reflectances				
Ceiling Cavity	70	70	50	50
Walls	50	30	50	30
Floor Cavity	20	20	20	20
Room Size	UGR Viewed Crosswise			
X=2H Y=2H	23.8	25.2	24.2	25.6
3H	24.2	25.5	24.6	25.9
4H	24.3	25.5	24.7	25.9
6H	24.3	25.4	24.7	25.8
8H	24.3	25.3	24.7	25.7
12H	24.2	25.2	24.7	25.6
4H	UGR Viewed Endwise			
2H	24.0	25.2	24.4	25.5
3H	24.6	25.5	25.0	26.0
4H	24.7	25.5	25.1	26.0
6H	24.7	25.4	25.2	25.9
8H	24.6	25.3	25.1	25.8
12H	24.6	25.2	25.1	25.7
8H	4H	24.7	25.4	25.1
6H	24.7	25.2	25.2	25.8
8H	24.6	25.1	25.1	25.7
12H	24.6	25.0	25.1	25.6
12H	4H	24.6	25.3	25.1
6H	24.6	25.1	25.2	25.6
8H	24.6	25.1	25.1	25.6
Maximum UGR = 27.1				



# HH-504-7-xx-PH3030

## 结构参数

v1.0\_20230223

注：(1) 所有计量单位均为 mm。  
 (2) 若无特殊说明，所有公差均为 ±0.15

### 1. 安装固定方式

- 胶水     
  螺丝     
  胶带     
  固定圈     
  支架

### 2. 透镜尺寸

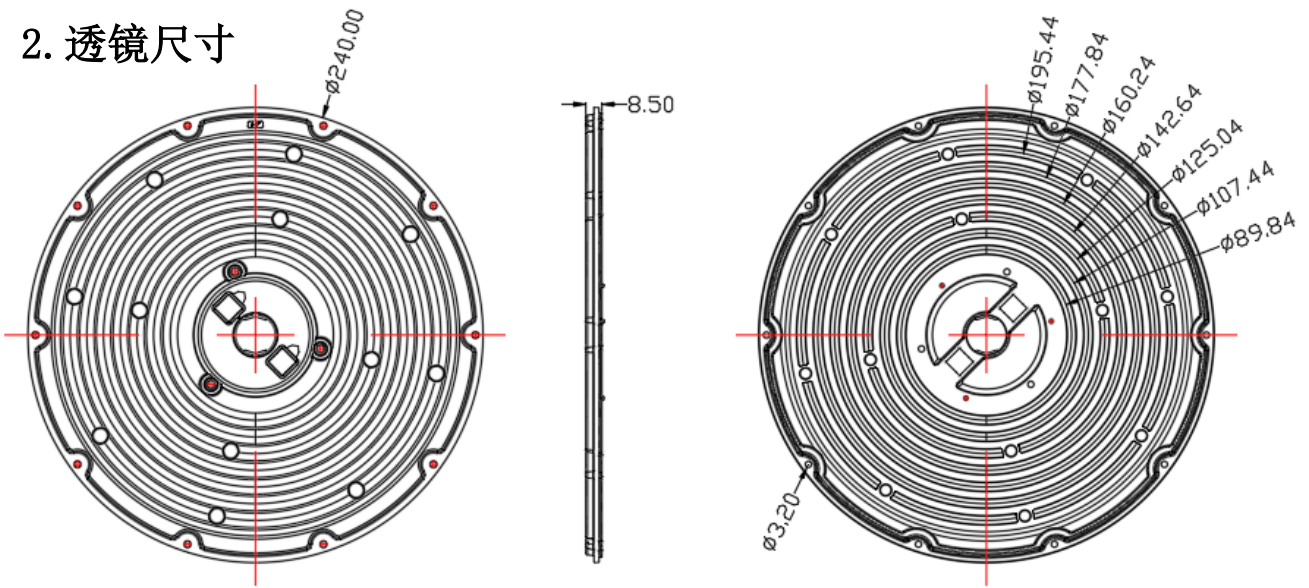

### 3. 装配指示

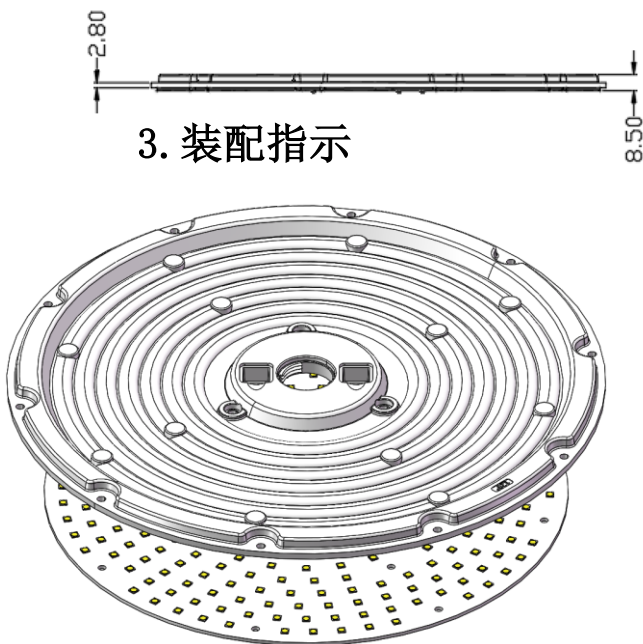

### 4. 透镜装配视图

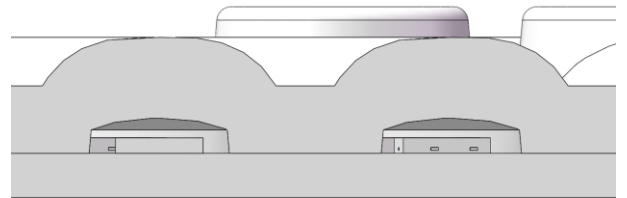

# HH-504-7-xx-PH3030

## 包装规格

v1.0\_20230223

项目	数量	全部	尺寸(L*W*H)	毛重
内盒				
外箱				



Note:

