

Data Sheet

HH-206-4-xx-PH3030

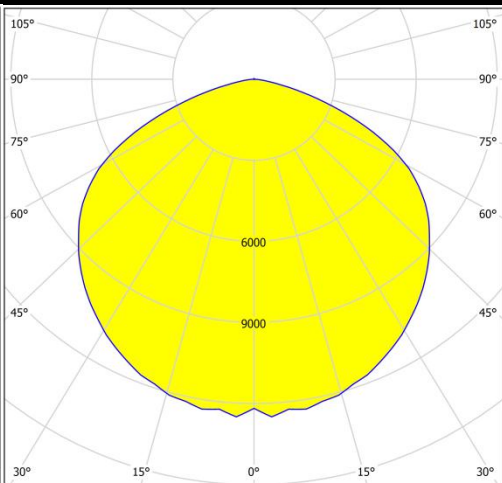
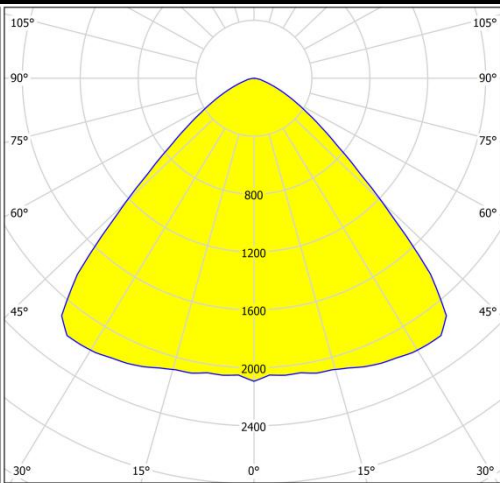
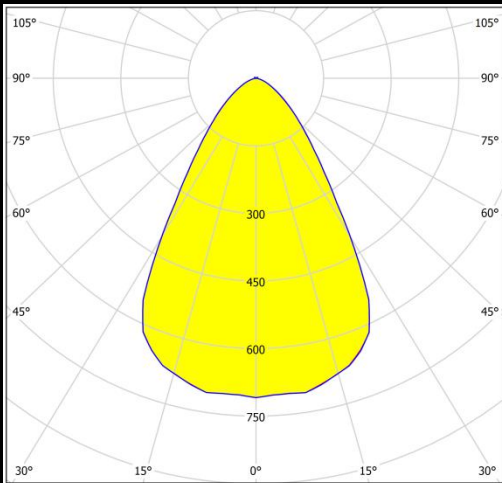
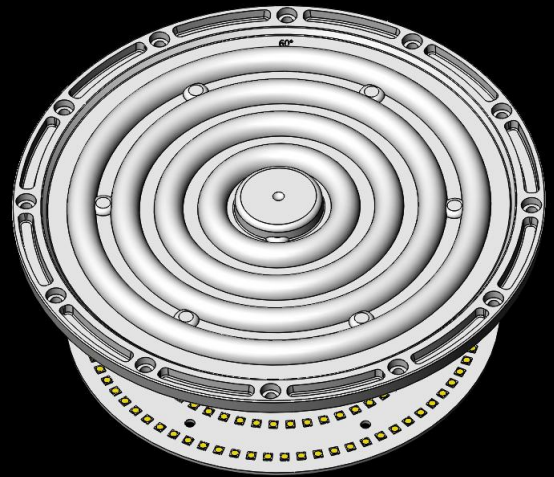

cd/klm

cd/klm

cd/klm

深圳市汉辉光电有限公司
shenzhen hanhui photoelectric co., Ltd.

地址：深圳市宝安区石岩街道石龙仔社区恒昌荣高科技科技园3栋3楼
ADD: Area A No.3 Building 3th Floor, Hengchang Rong Industrial
park shiyan, shilong community, Bao'an District, shenzhen, china
TEL: 86-755-29232420 FAX: 86-755-83723765
<http://www.szhanhui.com> <http://liinsen4880.1688.com>



Data Sheet

catalogue

General Information	P.1
Optical Specifications	P.2
Mechanical Specifications	P.3
Package Specifications	P.4

*Product Nomenclature

HH-206-4-xx-PH3030

H1 H2 H3 H4 H5 H6

H1: The company's initials in Pinyin (Han Hui)

H2: Mold number

H3: Lens quantity

H4: Lens angle/type (ex : 60、 90、 T2M、 T3M)

H5: LED type(ex : CREE-CR、 SAMSUNG-SS、 PHILIPS-PH.....)

H6: LED size (ex:2835、 3030、 3535、)



HH-206-4-xx-PH3030

General Information

v1.0_20181107

◆ Features & Typical Applications

- High efficiency
- optimized Uniformity
- Lens without Holder
- Commercial Lighting

◆ Material Information

Lens Material: PC 1225Z

Operating Temperature range $-40^{\circ}\text{C} \sim +110^{\circ}\text{C}$ (upper limit $+120^{\circ}\text{C}$).

Storage Temperature range $-40^{\circ}\text{C} \sim +110^{\circ}\text{C}$ (upper limit $+120^{\circ}\text{C}$).

*Average transmittance in visible spectrum $400\text{nm} \sim 700\text{nm} > 90\%$.

◆ Usage and Maintenance

1. If necessary, clean lenses with mild soap, water and soft cloth.
2. Never use any commercial cleaning solvents on lenses, like alcohol.
3. Please handle or install lenses with wearing gloves, skin oils may damage lens or its optical characteristic.



HH-206-4-xx-PH3030

Optical Specifications

v1.0_20181107

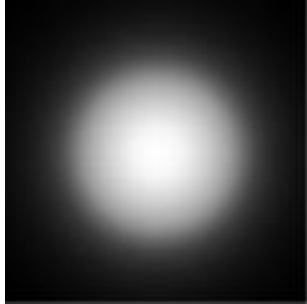
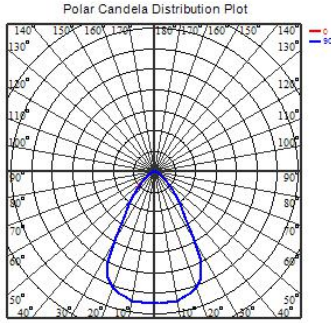
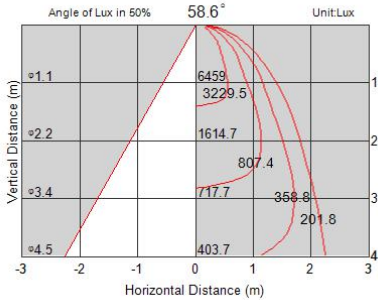
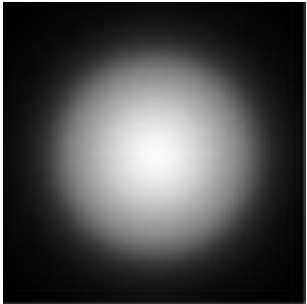
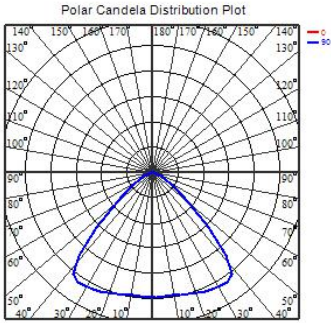
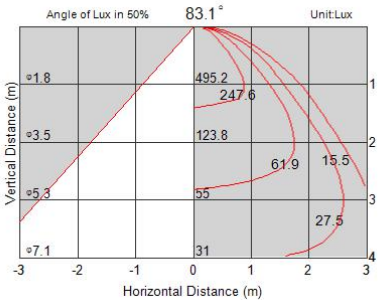
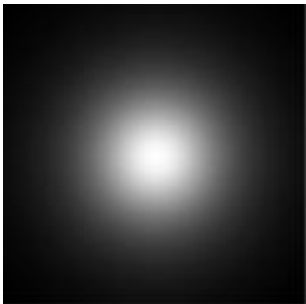
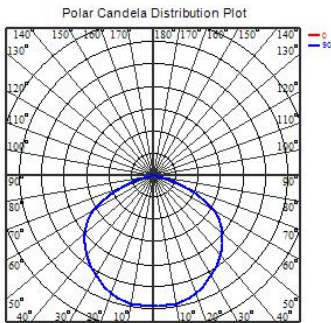
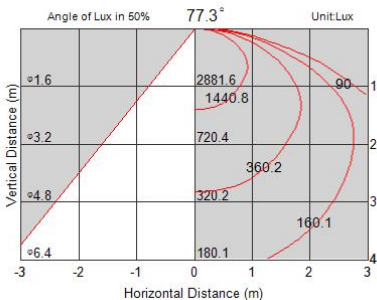
Part Number	FWHM	Field Angle	cd/lm	IES File
HH-206-4-60-PH3030	64.5°	108.5°	0.77	Download
				
Beam Pattern	Candela Distribution	Illuminance Distribution		
Part Number	FWHM	Field Angle	cd/lm	IES File
HH-206-4-90-PH3030	93.4°	128.1°	0.44	下载
				
Beam Pattern	Candela Distribution	Illuminance Distribution		
Part Number	FWHM	Field Angle	cd/lm	IES File
HH-206-4-120-PH3030	122.5°	152.7°	0.34	下载
				
Beam Pattern	Candela Distribution	Illuminance Distribution		



HH-206-4-xx-PH3030

Mechanical Specification

v1.0_20181107

Note: (1) All dimensions are in mm.
(2) All measurements are $\pm 0.15\text{mm}$ unless otherwise indicated.

1. Fixing method

Glue Screw Tape Fixing-ring Frame

2. Lens dimension

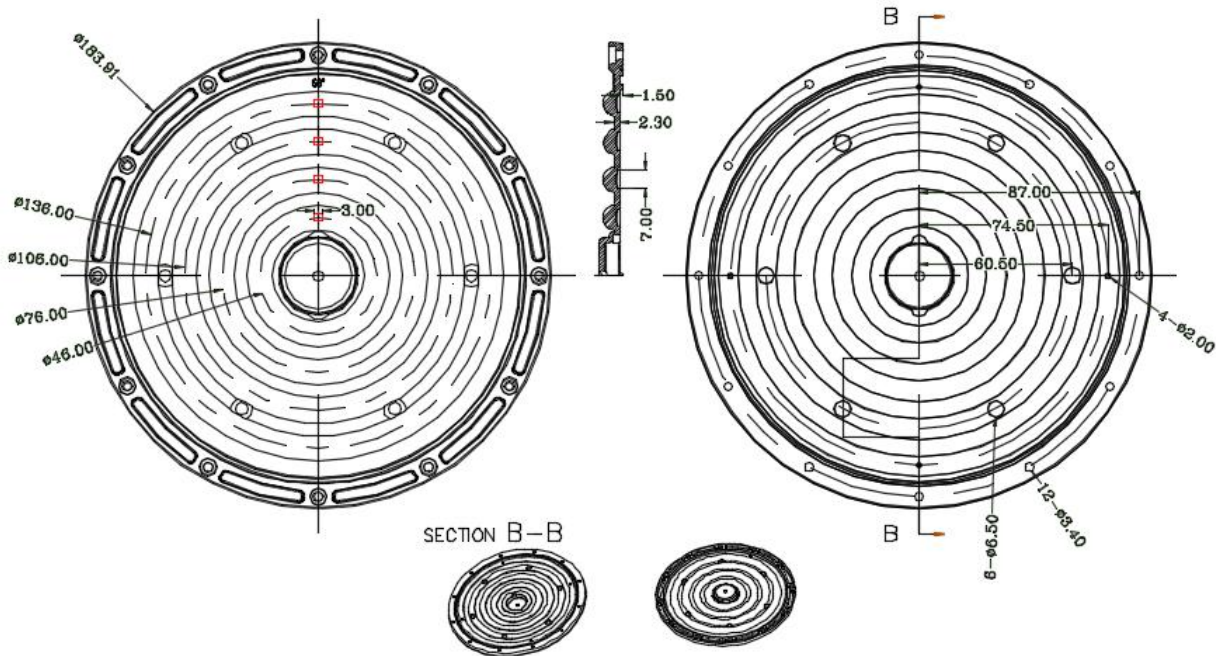

3. Assembly instruction

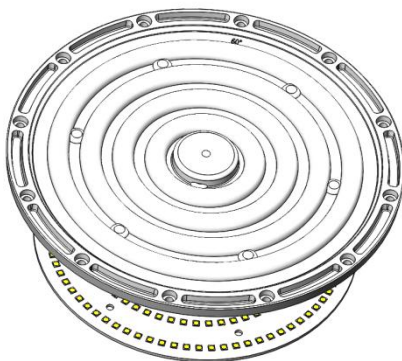

4. View assembly lens with MCPCB



HH-206-4-xx-PH3030

Mechanical Specification

v1.0_20181107

Item	Quantity	Total	Size(L*W*H)	G.W
plastic box	xx PCS/tier	xx PCS	27*27*26cm	
outer box	xx plastic box/outer box	xx PCS	57*28.5*28.5cm	

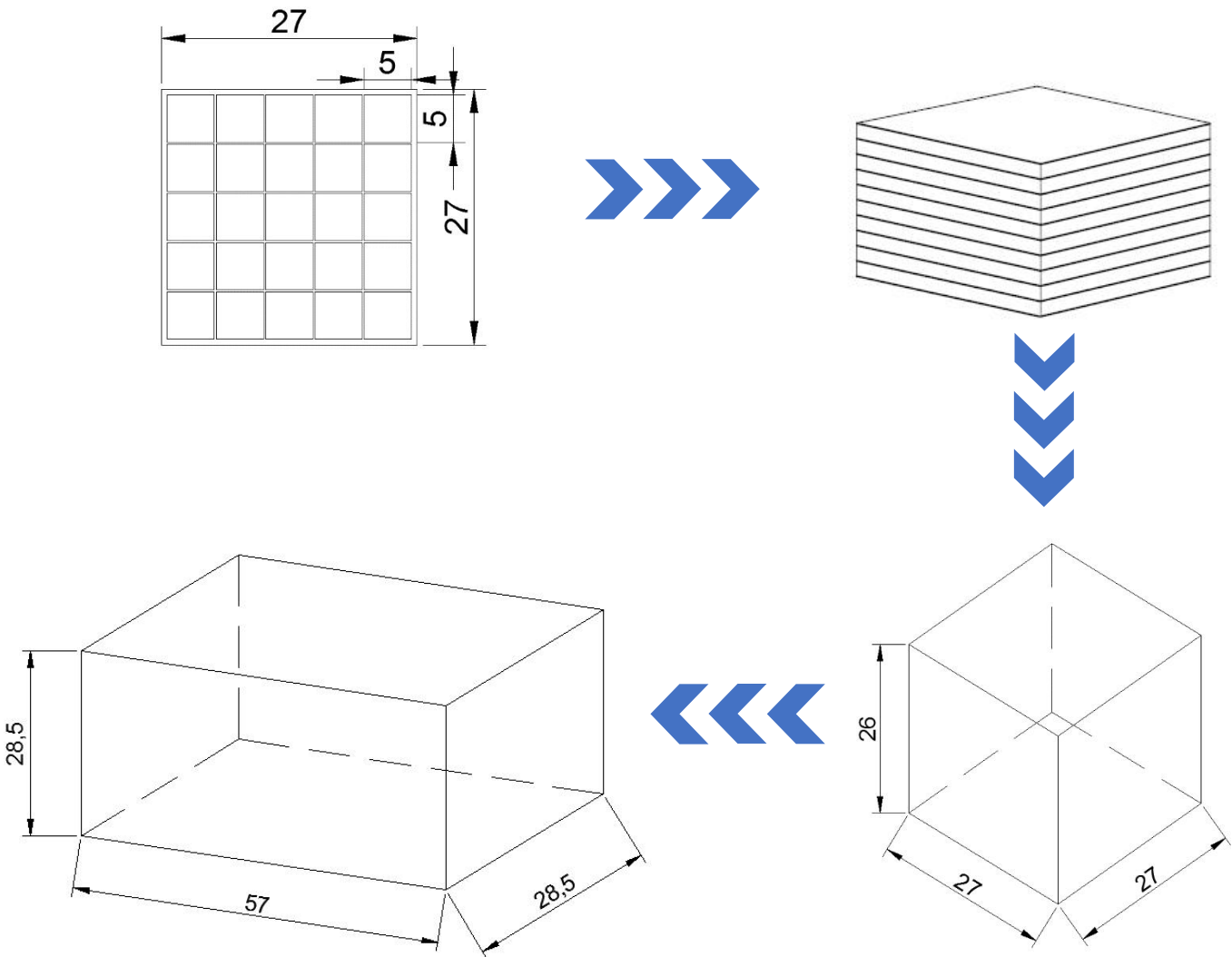

Note:

